

Saturnia / SMALL SUSPENSION
by Oskar Cerezo

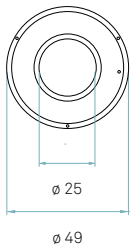

Catalogue Pg. 186-195, 263, 267

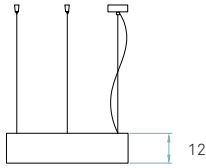

References

- SAT SP**
- SAT SP DIM**
Dimmable
- SAT SP DIMRC**
Dimmable
Remote control

Info

Light Emission
Direct / Diffused

Certificates

Class I

230V

Wood shade colors

- 20 Ivory White
- 21 Natural Cherry
- 22 Natural Beech
- 24 Yellow
- 25 Orange
- 26 Red
- 28 Blue
- 30 Turquoise
- 31 Chocolate



Components

Top diffuser
Black or White

It's important to select top diffuser colour

Bottom diffuser
Matt satin acrylic

Metal canopy
Brushed nickel
ø 8 cm

Electrical cable
Transparent
2 m drop

Steel cable
3 x 2 m drop

Packaging

Box size
60 x 60 x 32 cm

Box volume
0,115 m³

Weight
Gross - 5,5 Kg
Net - 2,7 Kg

Recommended tube (Included)

T5

Circline fluorescent
1 x 60 w

Dimming

For contract:
DALI / Switch /
Sensor Control

For home:
Remote Control
(Radio frequency
hand sender included)

Energy class

Tube included

Note: For other options, specify dimming needs



BALLAST INFO**Saturnia** / SMALL SUSPENSION
by Oskar Cerezo

Reference	Units	Ballast Reference	Family	Brand
SAT SP	1	22176171	PC PRO T8	TRIDONIC www.tridonic.com
SAT SP DIM Dimmable	1	913700761966	HF-Ri Touch DALI	PHILIPS www.lighting.philips.com
SAT SP DIMRC Dimmable Remote control	1 + 1 + 1	10096389 + CERF D10VDC MB (receptor) + HASE 2RF (wire-free hand senders)	BCD 1-10V + Radio Remote Controls	BAG www.bagelectronics.com DANLERS www.danlers.co.uk DANLERS www.danlers.co.uk

NOTE

These are our standard options, for other options, please specify dimming needs.



Wood shade colors Info References

-  20 IvoryWhite
-  21 Natural Cherry
-  22 Natural Beech
-  24 Yellow
-  25 Orange
-  26 Red
-  28 Blue
-  30 Turquoise
-  31 Chocolate



Light Emission
Direct / Diffused

Certificates



Class I 

230V

- SAT SM**
- SAT SM DIM**
Dimmable
- SAT SM DIMRC**
Dimmable
Remote control



Catalogue Pg. 186-195, 263, 267

Packaging Components



Box size
109 x 109 x 34 cm

Box volume
0,395 m³



Weight
Gross - 14,5 Kg
Net - 6,9 Kg



Metal canopy
Brushed nickel
ø 8 cm

Electrical cable
Transparent
2 m drop



Steel cable
3 x 2 m drop



Top diffuser
Black or White

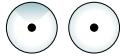

It's important to select
top diffuser colour

Bottom diffuser
Matt satin acrylic

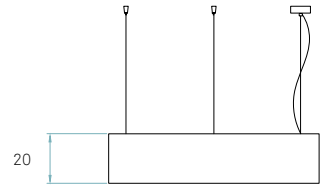

Recommended tube (Included)



T5



Linear fluorescent
3 x 24 w



Dimming

For contract:
DALI / DSI (Tridonic) /
Switch / Sensor Control



For home:
Remote Control
(Radio frequency
hand sender included)

Energy class



Tube included

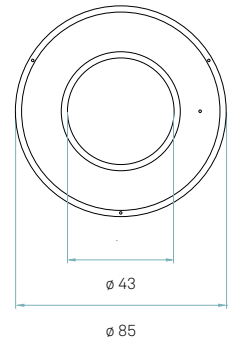

Note: For other options, please specify dimming needs

MEDIUM SUSPENSION / *Saturnia*
 by Oskar Cerezo

Reference	Units	Ballast Reference	Family	Brand
SAT SM	1	22185212	PC PRO T5	TRIDONIC www.tridonic.com
SAT SM DIM Dimmable	1	22176209	EXCEL T5	TRIDONIC www.tridonic.com
SAT SM DIMRC Dimmable Remote control	1 + 1 + 1 + 1	10097246 + 10097296 + CERF D10VDC MB (receptor) + HASE 2RF (wire-free hand senders)	BCD T5 1-10V + BCD T5 1-10V + Radio Remote Controls	BAG www.bagelectronics.com BAG www.bagelectronics.com DANLERS www.danlers.co.uk DANLERS www.danlers.co.uk

NOTE

These are our standard options, for other options, please specify dimming needs.

Saturnia / LARGE SUSPENSION
by Oskar Cerezo



Catalogue Pg. 186-195, 263, 267

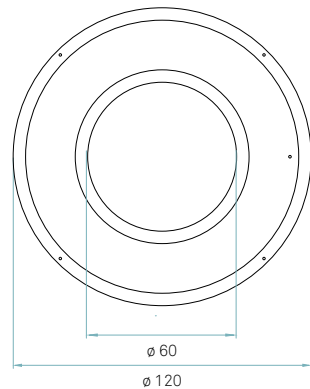
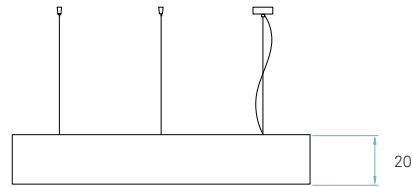

References

- SAT SG**
- SAT SG DIM**
Dimmable
- SAT SG DIM**
Dimmable
Remote control

Info

Light Emission
Direct / Diffused

Certificates

Class I

230V

Wood shade colors

- 20 Ivory White
- 21 Natural Cherry
- 22 Natural Beech
- 24 Yellow
- 25 Orange
- 26 Red
- 28 Blue
- 30 Turquoise
- 31 Chocolate



Components

Top diffuser
Black or White

It's important to select top diffuser colour

Bottom diffuser
Matt satin acrylic

Metal canopy
Brushed nickel
ø 8 cm

Electrical cable
Transparent
2 m drop

Steel cable
4 x 2 m drop

Packaging

Box size
138 x 138 x 37 cm
Wood crated for transport

Box volume
0,70 m³

Weight
Gross - 44 Kg
Net - 28,9 Kg

Recommended tube (Included)

T5

Linear fluorescent
4 x 24 w

Dimming

For contract:
DALI / DSI (Tridonic) /
Switch / Sensor Control

For home:
Remote Control
(Radio frequency
hand sender included)

Energy class

Tube included

Note: For other options, specify dimming needs



BALLAST INFO

Saturnia / LARGE SUSPENSION by Oskar Cerezo

Reference	Units	Ballast Reference	Family	Brand
SAT SG	1	22185212	PC PRO T5	TRIDONIC www.tridonic.com
SAT SG DIM Dimmable	2	22185104	EXCEL T5	TRIDONIC www.tridonic.com
SAT SG DIMRC Dimmable Remote control	2 + 1 + 1	10097296 + CERF D10VDC MB (receptor) + HASE 2RF (wire-free hand senders)	BCD T5 1-10V + Radio Remote Controls	BAG www.bagelectronics.com DANLERS www.danlers.co.uk DANLERS www.danlers.co.uk

NOTE

These are our standard options, for other options, please specify dimming needs.

